

# MAX5318 Evaluation System

## Evaluates: MAX5318

### General Description

The MAX5318 evaluation kit (EV kit) provides a proven design to evaluate the MAX5318 18-bit high-accuracy voltage output DAC with digital gain and offset control. The EV kit also includes Windows XP®, Windows Vista®, and Windows® 7-compatible software that provides a simple graphical user interface (GUI) for exercising the features of the IC.

The MAX5318 evaluation system (EV system) consists of the EV kit and a companion MAXUSB2XILINXMB serial interface board. The MAXUSB2XILINXMB interface board allows a PC to control the SPI interface and GPIOs using its USB port. Order the EV system for a complete PC-based evaluation of the IC.

The EV system includes an on-board direct digital synthesizer (DDS) that generates precision waveforms (sine, triangle, rising ramp, falling ramp, square, and arbitrary). The DDS clock can be selected from 375kHz to 10kHz. Waveform amplitude and offset can be controlled by the DDS or the internal controls of the IC. Arbitrary waveforms are defined by a simple CSV file that can easily be created from Excel or many other software programs. A synchronization output is also provided that indicates when a new cycle starts. In addition, all waveforms can be synchronized to an external signal.

The EV kit comes with an 18-bit MAX5318GTG+ precision DAC installed.

### Features

- ◆ On-Board Direct Digital Synthesis (Xilinx® Spartan®-3A FPGA)
- ◆ On-Board Waveform Memory (1M x 24-Bit SRAM)
- ◆ On-Board +4.096V Ultra-High-Precision Voltage Reference (MAX6126)
- ◆ SMA Connectors for Waveform Synchronization and DAC Output
- ◆ Proven High-Performance 18-Bit DAC PCB Layout
- ◆ Stand-Alone and GUI Operation Modes
- ◆ Eight Diagnostic LEDs
- ◆ Five Pushbuttons For Functionality Tests
- ◆ High-Speed SPI Interface
- ◆ High-Speed USB 2.0 USB-PC Connection (Cable Included)
- ◆ Windows XP-, Windows Vista-, and Windows 7-Compatible Software
- ◆ RoHS Compliant
- ◆ Fully Assembled and Tested

*Ordering Information appears at end of data sheet.*

### System Diagram

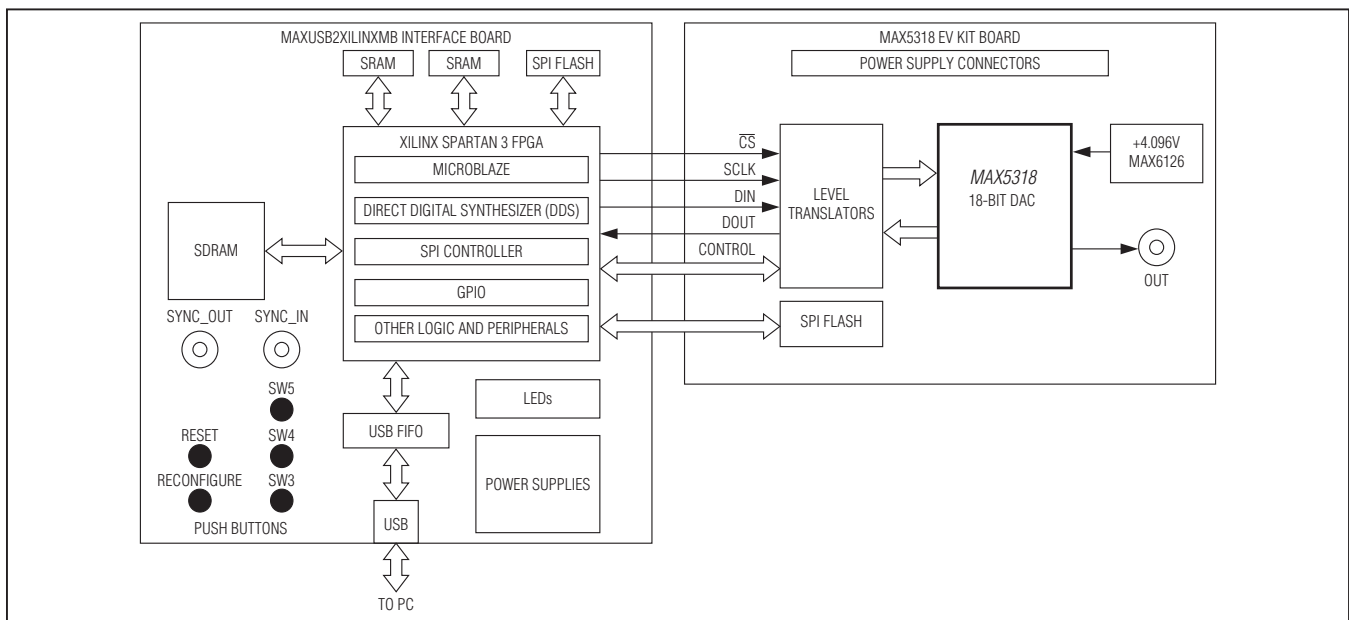

Windows, Windows XP, and Windows Vista are registered trademarks of Microsoft Corp.

Xilinx and Spartan are registered trademarks of Xilinx Inc.

**For pricing, delivery, and ordering information, please contact Maxim Direct at 1-888-629-4642, or visit Maxim's website at [www.maximintegrated.com](http://www.maximintegrated.com).**

# MAX5318 Evaluation System

## Evaluates: MAX5318

### Component Lists

#### MAX5318 EV System

PART	QTY	DESCRIPTION
MAX5318EVKIT#	1	MAX5318 EV kit
MAXUSB2XILINXMB#	1	Serial interface board

#### MAX5318 EV Kit

DESIGNATION	QTY	DESCRIPTION
C1, C5, C14, C15, C16, C19, C21, C23, C30–C37	16	0.1 $\mu$ F $\pm$ 10%, 16V X7R ceramic capacitors (0402) Murata GRM155R71C104K
C2, C4, C6, C8, C17, C20, C27, C28, C29, C63	10	0.01 $\mu$ F $\pm$ 10%, 16V X7R ceramic capacitors (0402) Murata GRM155R71C103K
C3, C9, C10, C11, C38–C40	7	1 $\mu$ F $\pm$ 10%, 16V X7R ceramic capacitors (0603) Murata GRM188R71C105K
C7, C60	2	100pF $\pm$ 5%, 50V C0G ceramic capacitors (0402) Murata GRM1555C1H101J
C12, C22, C42, C44, C46, C48, C50, C52, C55, C56, C58, C62, C65	13	180pF $\pm$ 5%, 50V C0G ceramic capacitors (0402) Murata GRM1555C1H181J
C13, C41, C43, C45, C47, C49, C51, C53, C54, C57, C59, C61, C64	13	1000pF $\pm$ 5%, 50V C0G ceramic capacitors (0402) Murata GRM155R71H102J
C18	1	4.7 $\mu$ F $\pm$ 10%, 6.3V X5R ceramic capacitor (0603) Murata GRM188R60J475K
C24, C25, C26	3	10 $\mu$ F $\pm$ 10%, 10V X7R ceramic capacitors (0805) Murata GRM21BR71A106K
D1	1	30V, 500mA Schottky diode (SOD123)
FB1–FB8	8	600 $\Omega$ $\pm$ 25% 500mA ferrite beads (0603) TDK MMZ1608B601C
J1	1	50 $\Omega$ SMA connector, vertical mount
J2	1	Self-mating hermaphroditic strip (2x20)
JU1, JU2	2	2-pin headers

DESIGNATION	QTY	DESCRIPTION
JU3, JU4, JU6	3	3-pin headers
JU5	1	5-pin header
R1, R5, R9–R30	24	22 $\Omega$ $\pm$ 5% resistors (0402)
R2	1	100k $\Omega$ $\pm$ 5% resistor (0603)
R3	1	10k $\Omega$ $\pm$ 5% resistors (0603)
R4	1	1k $\Omega$ $\pm$ 5% resistor (0603)
R6	1	0 $\Omega$ $\pm$ 5% resistor (0603)
R7	1	12.4k $\Omega$ $\pm$ 1% resistor (0603)
R8	1	10k $\Omega$ $\pm$ 1% resistor (0603)
TP1, TP2, TP3, TP8	4	Orange multipurpose test points
TP4, TP5, TP10	3	Red multipurpose test points
TP6, TP9, TP11, TP25–TP27	6	Black multipurpose test points
TP7	1	White multipurpose test point
TP12–TP24	13	Orange miniature test points
U1	1	18-bit DAC (24 TQFN-EP*) Maxim MAX5318GTG+
U2	1	+4.096V ultra-high-precision voltage reference (8 SO) Maxim MAX6126AASA41+
U4	1	SPI serial flash (8 SO8W)
U5	1	Negative output LDO (5 SOT23) Maxim MAX1735EUK30+
U6, U7, U8	3	2-bit level translators (8 SSOP)
U9	1	8-bit level translator (24 TSSOP)
U10	1	300mA LDO (6 SOT23) Maxim MAX1983EUT+
—	6	Shunts
—	1	PCB: MAX5318 EVALUATION KIT

\*EP = Exposed pad.

# MAX5318 Evaluation System

## Evaluates: MAX5318

### Component Suppliers

SUPPLIER	PHONE	WEBSITE
Murata Electronics North America Inc.	770-436-1300	www.murata-northamerica.com
TDK Corp.	847-803-6100	www.component.tdk.com

**Note:** Indicate that you are using the MAX5318 when contacting these component suppliers.

### MAX5318 EV Kit Files

FILE	DESCRIPTION
INSTALL.EXE	Installs the EV kit files on your computer
MAX5318EVKIT.EXE	Application program
CDM20600.EXE	Installs the USB device driver
UNINSTALL.EXE	Uninstalls the EV kit software
USB_Driver_Help_200.PDF	USB driver installation help file

### Quick Start

#### Required Equipment

- MAX5318 EV kit
- MAXUSB2XILINXMB interface board (USB cable included)
- Windows XP, Windows Vista or Windows 7 PC with a spare USB port
- Power supply, +5V DC at 600mA
- Power supply, -5V DC at 100mA
- Oscilloscope

**Note:** The EV system has two operation modes: stand-alone mode and GUI mode. See the *Detailed Description of Hardware* section for operation mode details.

#### Stand-Alone Mode Procedure

- 1) Verify that the jumpers on the MAXUSB2XILINXMB interface board are in their default positions as shown in Table 3.
- 2) Verify that the jumpers on the EV kit board are in their default positions, as shown in Table 4.
- 3) Connect the EV kit board to the MAXUSB2XILINXMB interface board.
- 4) Connect +5V DC power supply to the MAXUSB2XILINXMB interface board between TP1 (+5V) and TP2 (GND). Keep power off.
- 5) Connect +5V DC power supply to the EV kit between TP5 (+5V) and TP6 (AGND). Keep power off.
- 6) Connect -5V DC power supply to the EV kit between TP7 (-5V) and TP6 (AGND). Keep power off.
- 7) Connect oscilloscope probe 1 to the EV kit SMA connector J1 or test point TP1 (OUT).
- 8) Turn on the power supplies for the EV kit board first. Then turn on the power supply for the MAXUSB2XILINXMB board.
- 9) Observe that the DAC outputs a sine wave of 1kHz, amplitude range is 0 to 4.096V.
- 10) Press and release SW3 to select between 8 sine waveforms with different frequencies. A single LED from LED4–LED11 is turned on, indicating a different frequency, as shown in Table 1.
- 11) Press and release SW4 to select between 8 sine waveforms with different frequencies. A single LED from LED4–LED11 is turned off, indicating a different frequency, as shown in Table 2.
- 12) Press SW5 to toggle TC/ $\overline{SB}$  logic level. By default, TC/ $\overline{SB}$  = high and the DDS output is set to two's-complement format. If TC/ $\overline{SB}$  = low, the sine waveform is distorted.
- 13) Press SW1 (RESET) to reset the MAXUSB2XILINXMB board and the EV kit board.

# MAX5318 Evaluation System

## Evaluates: MAX5318

**Table 1. LED4–LED11 Relationship With DAC Output Frequency Controlled by SW3**

SINGLE LED TURNED ON	PINC VALUE	DAC OUTPUT SINE WAVEFORM FREQUENCY (Hz)
LED4	83,886	999.999046
LED5	83,968	1000.976563
LED6	38,858	463.223457
LED7	419	4.994869
LED8	838,861	10000.002384
LED9	838,912	10000.610351
LED10	65,536	781.250000
LED11	256	3.051758

**Table 2. LED4–LED11 Relationship With DAC Output Frequency Controlled by SW4**

SINGLE LED TURNED OFF	PINC VALUE	DAC OUTPUT SINE WAVEFORM FREQUENCY (Hz)
LED4	1,048,576	12500.000000
LED5	262,144	3125.000000
LED6	65,536	781.250000
LED7	16,384	195.312500
LED8	4096	48.828125
LED9	1024	12.207031
LED10	256	3.051758
LED11	64	0.762939

### GUI Mode Procedure

**Note 1:** In the GUI mode operation, the stand-alone mode functions as described in the previous section. The user can exercise more features of the EV kit using the GUI mode. Each time when the operation mode is to be changed, a user needs to press and release SW1 (RESET) on the MAXUSB2XILINXMB board to reset the EV system and then follow the procedures for each operation mode.

**Note 2:** In the following sections, software-related items are identified by bolding. Text in bold refers to items directly from the EV kit software. Text in **bold and underlined** refers to items from the Windows operating system.

- 1) Visit [www.maximintegrated.com/evkitsoftware](http://www.maximintegrated.com/evkitsoftware) to download the latest version of the EV kit software, 5318Rx.ZIP. Save the EV kit software to a temporary folder and uncompress the ZIP file.
- 2) Install the EV kit software and USB driver on your computer by running the INSTALL.EXE program inside the temporary folder. The program files are copied to your PC and icons are created in the Windows **Start | Programs** menu. During software installation, some versions of Windows may show a warning message indicating that this software is from an unknown publisher. This is not an error condition and it is safe to proceed with installation. Administrator privileges are required to install the USB device driver on Windows.
- 3) Verify that the jumpers on the MAXUSB2XILINXMB interface board are in their default positions, as shown in Table 3.
- 4) Verify that the jumpers on the EV kit board are in their default positions, as shown in Table 4.
- 5) Connect the EV kit board to the MAXUSB2XILINXMB interface board.
- 6) Connect +5V DC power supply to the MAXUSB2XILINXMB interface board between TP1 (+5V) and TP2 (GND). Keep power off.
- 7) Connect +5V DC power supply to the EV kit between TP5 (+5V) and TP6 (AGND). Keep power off.
- 8) Connect -5V DC power supply to the EV kit between TP7 (-5V) and TP6 (AGND). Keep power off.
- 9) Connect oscilloscope probe 1 to the EV kit SMA connector J1 or test point TP1 (OUT).
- 10) Connect oscilloscope probe 2 to EV kit test point TP20 ( $\overline{CS}$ ).
- 11) Connect oscilloscope probe 3 to EV kit test point TP19 (SCLK).
- 12) Connect oscilloscope probe 4 to EV kit test point TP18 (DIN).
- 13) Turn on the power supplies for the EV kit board first. Then turn on the power supply for the MAXUSB2XILINXMB board.

# MAX5318 Evaluation System

## Evaluates: MAX5318

- 14) Observe that the DAC outputs a sine wave of 1kHz, amplitude range is 0 to 4.096V.
- 15) Connect the USB cable from the PC to the MAXUSB2XILINX board. A Windows message appears when connecting the MAXUSB2XILINX board to the PC for the first time. Each version of Windows has a slightly different message. If you see a Windows message stating **ready to use**, then proceed to the next step. Otherwise, open the USB\_Driver\_Help\_200.PDF document in the Windows **Start | Programs** menu to verify that the USB driver was installed successfully.
- 16) Start the EV kit software by opening its icon in the Windows **Start | Programs** menu. The EV kit software main window appears, as shown in Figure 2. Within 5s, the software should automatically connect to the hardware; verify that **MAX5318EVKIT Hardware Connected** appears in the bottom-left status bar.
- 17) Observe that the IC's OUT waveform is a 1kHz sine wave.
- 18) Drag the **Frequency** track bar up and observe that the output frequency increases.

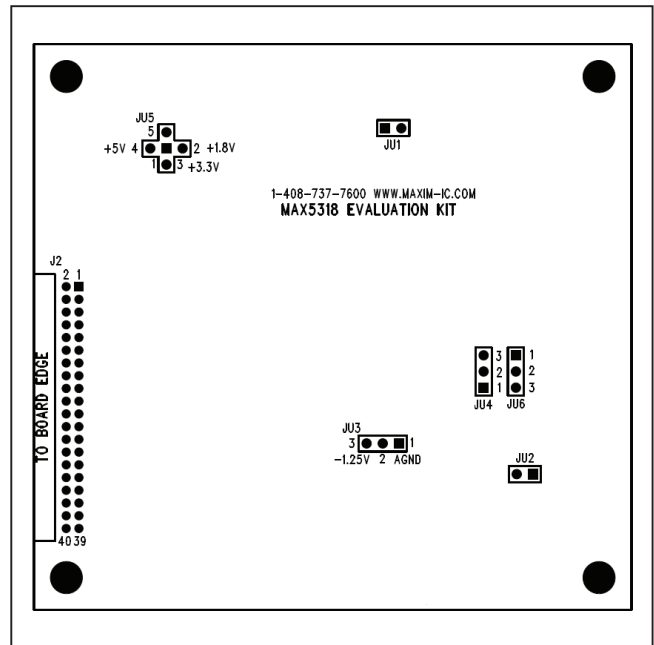

Figure 1. MAX5318 EV Kit Jumper Locations

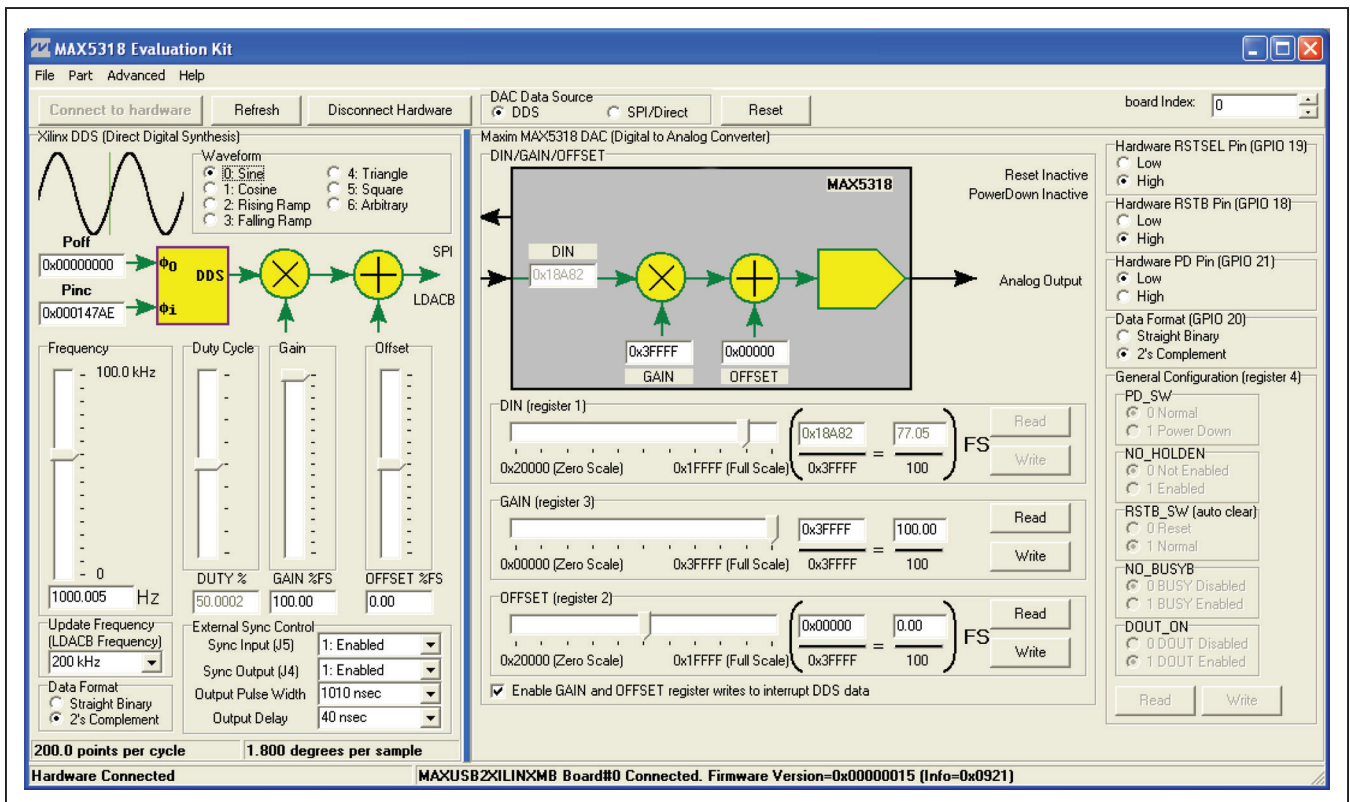

Figure 2. MAX5318 EV Kit Software Main Window (Block Diagram Tab)

# MAX5318 Evaluation System

## Evaluates: MAX5318

### ***Detailed Description of Software***

The main window of the evaluation software (shown in Figure 1) displays the MAXUSB2XILINXMB DDS signal generator on the left side of the window, and the MAX5318 DAC on the right side.

When **DAC Data Source** is set to **DDS**, the MAX5318 DIN register is driven by the DDS signal generator. The output frequency is controlled by the **Frequency** track bar, or by typing the output frequency value into its edit field and pressing enter. The sample update rate is controlled by the **Update Frequency** drop-down box.

The DDS output waveform frequency is calculated as follows:

$$f_{\text{OUT}} = \frac{f_{\text{UPDATE}} \times P_{\text{INC}}}{2^{24}}$$

Where  $f_{\text{UPDATE}}$  is the DDS update frequency,  $P_{\text{INC}}$  is the DDS phase increment. The DDS is implemented with a 24-bit phase accumulator.

The gain and offset of the DDS output waveform can be adjusted by the **Gain** and **Offset** track bars in the DDS section of the GUI.

The shape of the waveform is selected by the **Waveform** group box. The SPI clock frequency is selectable under the **Advanced** menu. Selecting a slower SPI clock frequency may limit the available update frequency. If the IC's **GAIN** and **OFFSET** registers are changed, the software briefly disables the DDS while performing the requested write operations, then automatically re-enables the DDS.

When **DAC Data Source** is set to **SPI/Direct**, the IC's DIN register is driven by the controls on the right side of the window. Write the **DIN**, **GAIN**, or **OFFSET** register by dragging its track bar, or by typing numbers into the corresponding edit fields.

When the MAXUSB2XILINXMB is powered up and connected to the computer's USB port, the software automatically connects and configures the IC to enable data output. This can be prevented by unchecking the **Advanced** menu item's **Connect Automatically** and **Enable DOUT After Connecting**.

#### ***Arbitrary Waveform Generation***

The DDS can accept user-defined arbitrary waveform data stored in a comma-separated values (CSV) file. There are 1,048,576 samples stored in the file, representing one cycle of the arbitrary waveform. The sample data are 18-bit decimal values with 0 representing zero scale and 262,143 representing full scale. Click the **File** menu item **Load Arbitrary Waveform...** to download the waveform to the DDS and stream to the DAC.

A staircase waveform is stored in the system at power-up.

### ***Detailed Description of Hardware***

The MAX5318 EV kit can operate in two modes: stand-alone and GUI.

The stand-alone mode is for quick IC functionality demonstration purposes only. In this mode, the MAXUSB2XILINXMB interface board generates one of 16 predefined digital signals using the DDS implemented on the FPGA.

Press and release SW3 to select between eight sine waveforms with different frequencies. A single LED from LED4–LED11 is turned on, indicating a different frequency, as shown in Table 1.

Press and release SW4 to select between eight sine waveforms with different frequencies. A single LED from LED4–LED11 is turned off, indicating a different frequency, as shown in Table 2.

In the stand-alone mode, the DAC is updated at 200kHz, the SPI clock speed is set at 10MHz.

The GUI mode is for a complete feature exercise of the IC through a PC. The user can explore many different application cases (e.g., DAC update frequencies, DAC output waveforms, DAC register settings, and DAC interface speed selections, etc).

The EV kit provides a proven layout for the 18-bit high-precision voltage output DAC. An on-board +4.096V voltage reference (MAX6126) is provided. Contact Maxim for other high-precision voltage references if reference voltages other than +4.096V are required.

#### ***SYNC\_IN and SYNC\_OUT Signals***

There is an SMA connector (J5) labeled INPUT and another SMA connector (J4) labeled OUTPUT on the MAXUSB2XILINXMB interface board. The INPUT signal is called SYNC\_IN and the OUTPUT signal is called SYNC\_OUT, respectively.

The SYNC\_IN signal is applied to the Schmitt-trigger input and the Schmitt-trigger output is applied to the FPGA DDS module. The SYNC\_IN is used to implement a simple "crash lock" for the DDS signal generator. At the rising edge of the SYNC\_IN clock, the DDS resets itself and the DDS phase accumulator is reset to the POFF value written by the GUI (default to 0).

The SYNC\_OUT signal shows when the generated waveform starts a new cycle.

Set the SYNC\_In\_Out\_Width register bit 31 to 1 to enable the SYNC\_IN signal. Set the bit to 0 to disable the SYNC\_IN signal.

Set the SYNC\_In\_Out\_Width register bit 30 to 1 to enable the SYNC\_OUT signal. Set the bit to 0 to disable the SYNC\_OUT signal.

# MAX5318 Evaluation System

## Evaluates: MAX5318

Set the SYNC\_In\_Out\_Width register bit 29 to bit 0 to control the SYNC\_OUT pulse width:

$$\text{SYNC\_OUT pulse width} = \text{SYNC\_In\_Out\_Width}[29:0] \times 10\text{ns}$$

When SYNC\_In\_Out\_Width[29:0] = 0, the SYNC\_OUT pulse width = 10ns.

### Pushbuttons on the MAXUSB2XILINXMB Interface Board

There are five pushbuttons (SW1–SW5) on the MAXUSB2XILINXMB interface board. Their functions are described as follows:

**FPGA Reconfigure Button (SW1):** Press and release this button to reconfigure the FPGA and the whole interface board.

**CPU Reset Button (SW2):** Press and release this button to reset the embedded MicroBlaze microcontroller and the interface board.

**Sinusoid Frequency-Select Button (SW3):** Press and release this button to select between eight sine waveforms with different frequencies. A single LED from LED4–LED11 is turned on, indicating a different frequency, as shown in Table 1.

**Sinusoid Frequency-Select Button (SW4):** Press and release this button to select between eight sine waveforms with different frequencies. A single LED from LED4–LED11 is turned off, indicating a different frequency, as shown in Table 2.

**TC/SB IC Pin Logic-Level Select Button (SW5):** Press and release this button to toggle the TC/SB IC pin logic. After the FPGA reconfiguration or the embedded MicroBlaze microcontroller reset, the TC/SB pin is logic-high and the DDS output is set to two's-complement format. If TC/SB = low, the sine waveform is distorted.

**Table 3. MAXUSB2XILINXMB Interface Board Jumper Descriptions (JU1–JU13)**

JUMPER	SHUNT POSITION	DESCRIPTION
JU1	1-2	IOVDD = 1.8V from U9. Do not use.
	1-3*	IOVDD = 3.3V from U7.
	1-4	IOVDD = external user-supplied IOVDD from test point TPEXTIOVDD. Do not use.
JU2	Pin 1 only*	FPGA mode signal M0 = 1.
	1-2	FPGA mode signal M0 = 0. Do not use.
JU3	Pin 1 only	FPGA mode signal M1 = 1. Do not use.
	1-2*	FPGA mode signal M1 = 0.
JU4	Pin 1 only	FPGA mode signal M2 = 1. Do not use.
	1-2*	FPGA mode signal M2 = 0.
JU5	Pin 1 only*	FPGA VS2 = 1.
	1-2	FPGA VS2 = 0. Do not use.
JU6	Pin 1 only*	FPGA VS1 = 1.
	1-2	FPGA VS1 = 0. Do not use.
JU7	Pin 1 only*	FPGA VS0 = 1.
	1-2	FPGA VS0 = 0. Do not use.
JU8	1-2*	HOLD1 is connected to ground.
	2-3	HOLD2 is connected to ground.

JUMPER	SHUNT POSITION	DESCRIPTION
JU9	1-2*	U7 powers the 3.3V supply rail.
	Open	Measure the MAXUSB2XILINXMB 3.3V supply current by putting a current meter in series with the jumper.
JU10	1-2*	U8 powers the 0.9V supply rail.
	Open	Measure the MAXUSB2XILINXMB 0.9V supply current by putting a current meter in series with the jumper.
JU11	1-2*	U10 powers the 1.2V supply rail.
	Open	Measure the MAXUSB2XILINXMB 1.2V supply current by putting a current meter in series with the jumper.
JU12	1-2*	U9 powers the 1.8V supply rail.
	Open	Measure the MAXUSB2XILINXMB 1.8V supply current by putting a current meter in series with the jumper.
JU13	1-2*	Power U7–U10 from external user-supplied +5V DC supply (from test point TP1).
	2-3	Power U7–U10 from USB (for FPGA configurations with sufficiently low power). Do not use.

\*Default position.

# MAX5318 Evaluation System

## Evaluates: MAX5318

**Table 3. MAXUSB2XILINXMB Interface Board Jumper Descriptions (JU1–JU13) (continued)**

JUMPER	SHUNT POSITION	DESCRIPTION	JUMPER	SHUNT POSITION	DESCRIPTION
JUTCK	1-2	Do not use.	JUTDO	1-2	Do not use.
	2-3	Do not use.		2-3	Do not use.
	Pin 1 only*	USB bridge does not drive J2 or J3.		Pin 1 only*	USB bridge does not drive J2 or J3.
JUTDI	1-2	Do not use.	JUTMS	1-2	Do not use.
	2-3	Do not use.		2-3	Do not use.
	Pin 1 only*	USB bridge does not drive J2 or J3.		Pin 1 only*	USB bridge does not drive J2 or J3.

**Table 4. EV Kit Jumper Descriptions (JU1–JU6)**

JUMPER	SHUNT POSITION	DESCRIPTION	JUMPER	SHUNT POSITION	DESCRIPTION
JU1	1-2*	AVDD is connected to TP5 (+5V).	JU4, JU6	1-2*	REF is connected to on-board +4.096V reference.
	Pin 1 only	AVDD is connected to external supply on TP4.		2-3	REF is connected to external reference on TP8.
JU2	1-2*	RFB is connected to OUT.	JU5	1-2	VDDIO is connected to 1.8V power supply.
	Pin 1 only	RFB is disconnected from OUT.		1-3*	VDDIO is connected to 3.3V power supply.
JU3	1-2	AVSS is connected to analog ground.		1-4	VDDIO is connected to 5V power supply.
	2-3*	AVSS is connected to on-board -1.25V reference.		1-5	VDDIO is connected to external supply on TP10.

\*Default position.



# MAX5318 Evaluation System

## Evaluates: MAX5318

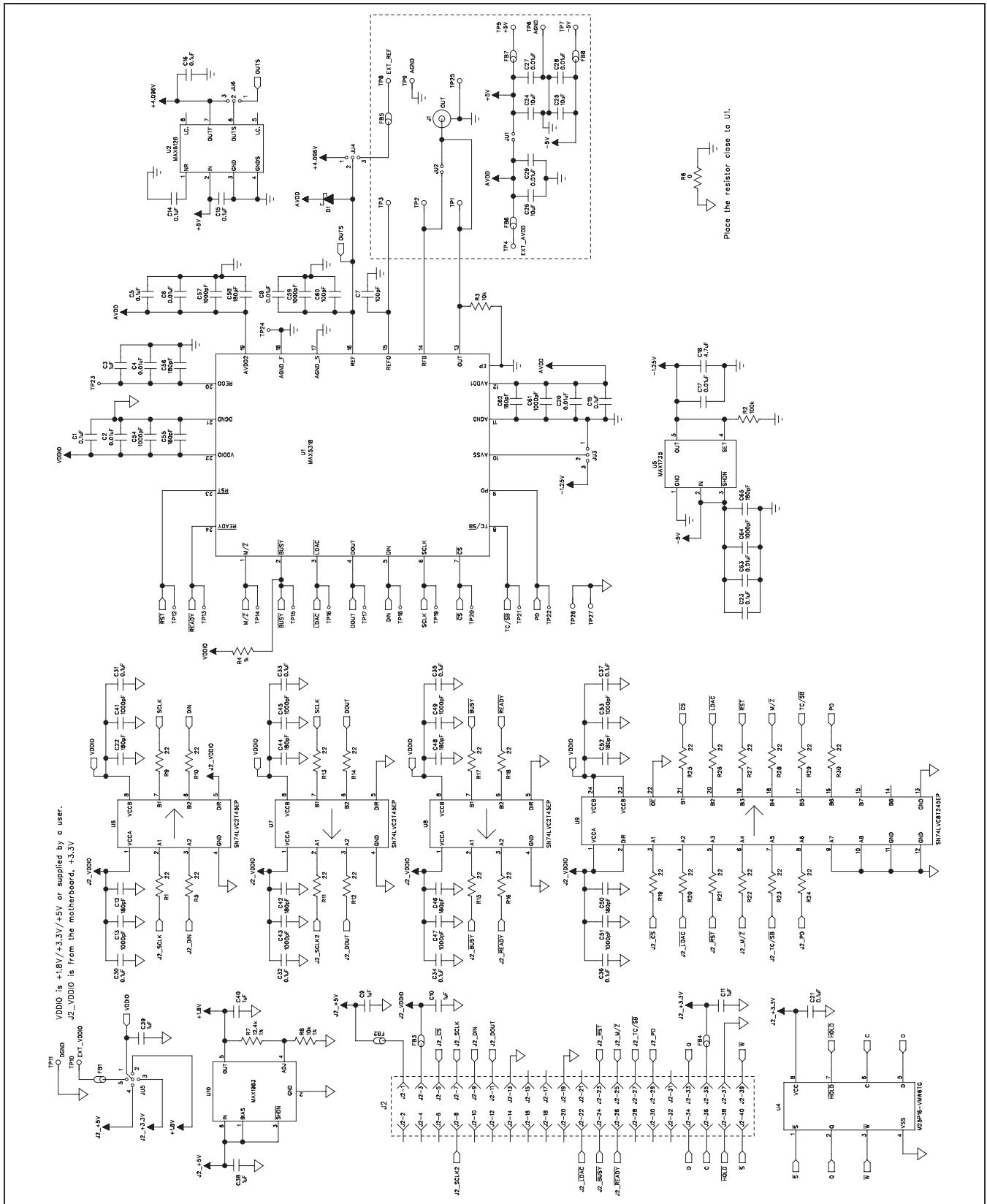

Figure 3. MAX5318 EV Kit Schematic  
Maxim Integrated

# MAX5318 Evaluation System

## Evaluates: MAX5318

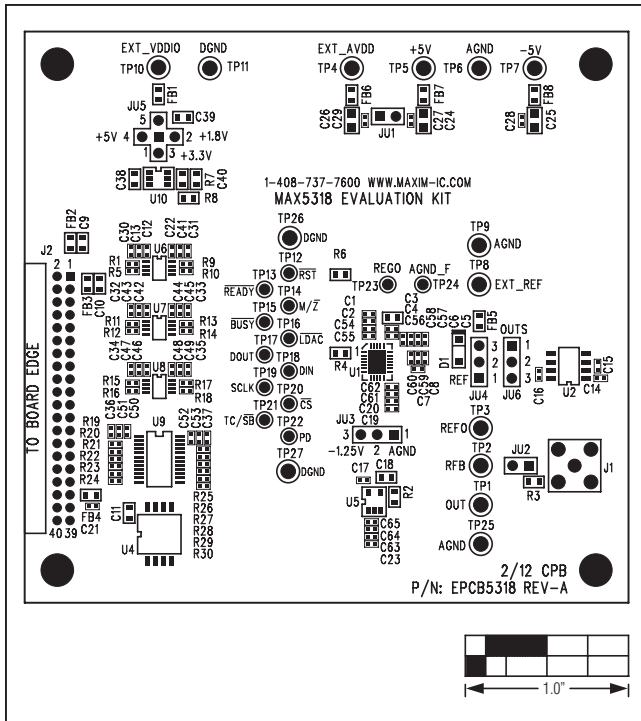

Figure 4. MAX5318 EV Kit Component Placement Guide—Component Side

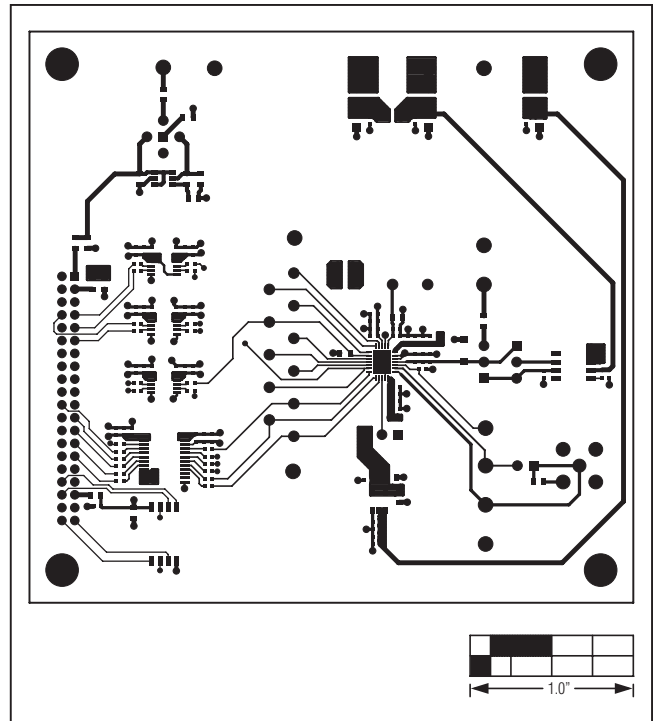

Figure 5. MAX5318 EV Kit PCB Layout—Component Side

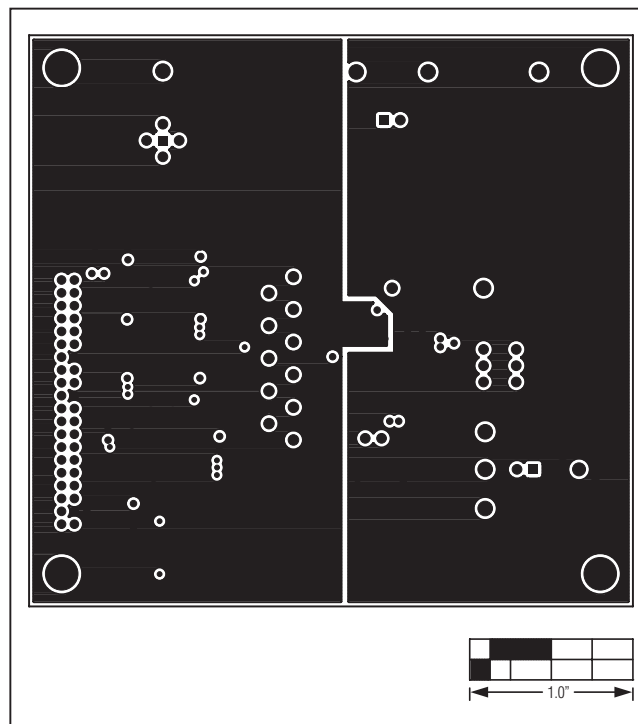

Figure 6. MAX5318 EV Kit PCB Layout—Ground Layer 2

# MAX5318 Evaluation System

## Evaluates: MAX5318

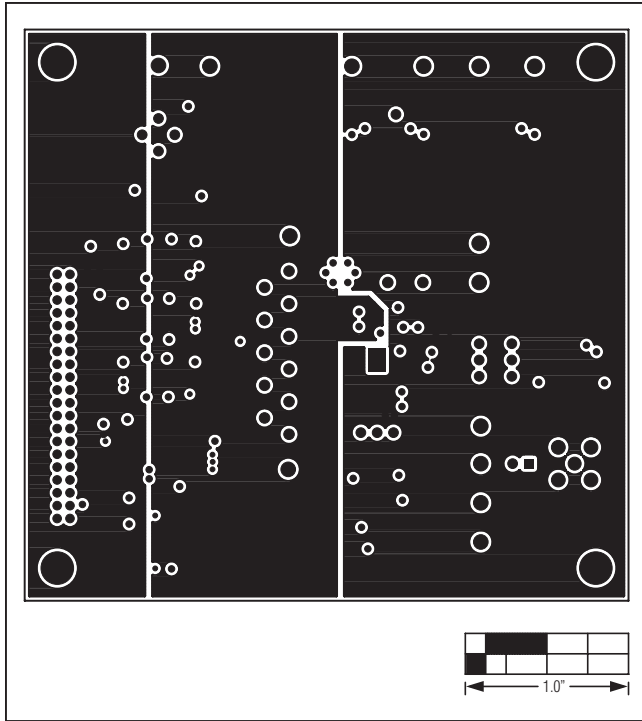

Figure 7. MAX5318 EV Kit PCB Layout—Power Layer 3

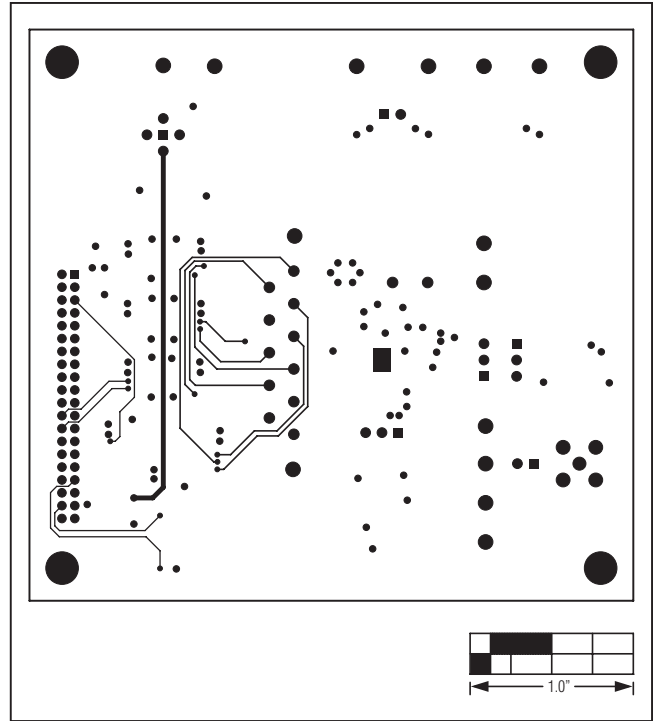

Figure 8. MAX5318 EV Kit PCB Layout—Solder Side

# MAX5318 Evaluation System

## Evaluates: MAX5318

### ***Ordering Information***

---

<b>PART</b>	<b>TYPE</b>
MAX5318EVSYS#	EV System

*#Denotes RoHS compliant.*

# MAX5318 Evaluation System

## Evaluates: MAX5318

### *Revision History*

REVISION NUMBER	REVISION DATE	DESCRIPTION	PAGES CHANGED
0	3/12	Initial release	—



*Maxim cannot assume responsibility for use of any circuitry other than circuitry entirely embodied in a Maxim product. No circuit patent licenses are implied. Maxim reserves the right to change the circuitry and specifications without notice at any time. The parametric values (min and max limits) shown in the Electrical Characteristics table are guaranteed. Other parametric values quoted in this data sheet are provided for guidance.*

**Maxim Integrated 160 Rio Robles, San Jose, CA 95134 USA 1-408-601-1000**

13

© 2012 Maxim Integrated Products, Inc. The Maxim logo and Maxim Integrated are trademarks of Maxim Integrated Products, Inc.